

Continuous isotopic composition measurements of tropospheric CO₂ at Jungfraujoch (3580 m a.s.l.), Switzerland: real-time observation of regional pollution events

B. Tuzson, S. Henne, D. Brunner, M. Steinbacher, J. Mohn, B. Buchmann, and L. Emmenegger

Empa, Swiss Federal Laboratories for Materials Science and Technology, Laboratory for Air Pollution and Environmental Technology, Überlandstr. 129, 8600 Dübendorf, Switzerland

Received: 27 September 2010 – Published in Atmos. Chem. Phys. Discuss.: 20 October 2010

Revised: 11 February 2011 – Accepted: 15 February 2011 – Published: 22 February 2011

Abstract. A quantum cascade laser based absorption spectrometer (QCLAS) is applied for the first time to perform in situ, continuous and high precision isotope ratio measurements of CO₂ in the free troposphere. Time series of the three main CO₂ isotopologue mixing ratios (¹²C¹⁶O₂, ¹³C¹⁶O₂ and ¹²C¹⁸O¹⁶O) have simultaneously been measured at one second time resolution over two years (from August 2008 to present) at the High Altitude Research Station Jungfraujoch (3580 m a.s.l., Switzerland). This work focuses on periods in February 2009 only, when sudden and pronounced enhancements in the tropospheric CO₂ were observed. These short-term changes were closely correlated with variations in CO mixing ratios measured at the same site, indicating combustion related emissions as potential source. The analytical precision of 0.046‰ (at 50 s integration time) for both δ¹³C and δ¹⁸O and the high temporal resolution allowed the application of the Keeling plot method for source signature identification. The spatial origin of these CO₂ emission sources was then determined by backward Lagrangian particle dispersion simulations.

et al., 1999). Currently, CO₂ resulting from the burning of fossil fuel (8 GtC yr⁻¹) represents the single largest perturbation to the atmospheric budget on an annual basis for total carbon. However, accounting for the fate of this anthropogenic CO₂ in every detail is still very challenging (Archer et al., 2009), because of the complexity and variability of the global cycles in which CO₂ is involved (Tans et al., 1989; Conway et al., 1994; Francey et al., 1995; Keeling et al., 1995; Randerson et al., 1997). Stable isotopic composition measurement of atmospheric CO₂ can provide additional and essential information about the various pathways and processes. The ¹³C isotopic distribution for example, allows for partitioning between land and ocean uptake (3 GtC yr⁻¹) (Ciais et al., 1995). This is due to the differences in isotopic discrimination against ¹³C associated with terrestrial ecosystem photosynthesis/respiration (~ 16‰) and air-sea gas exchange (~ 2‰). Likewise, anthropogenic CO₂ originating mainly from fossil fuel burning has a distinguishable isotopic signature that can be used as a tracer to understand and identify the sources and their temporal and spatial variations (Pataki et al., 2003).

1 Introduction

The accentuated mixing ratio increase of carbon dioxide (CO₂) and other trace gases in the Earth's atmosphere related to human activities is of major concern for climate change, because these anthropogenic emissions are gaining a significant role as an additional external forcing factor (Andres

Similarly, the oxygen isotope composition of atmospheric CO₂ was also shown to be a powerful tracer of photosynthetic and respiratory carbon fluxes, but its application to carbon cycle studies is challenging, as has been reported by several studies (Francey and Tans, 1987; Yakir and Wang, 1996; Ciais et al., 1997). The complexity of the δ¹⁸O data interpretation is due to the presence of an additional exchange of oxygen isotopes of CO₂ with water in leaves and soils, that is, isotope exchange without concentration changes. This creates severe limitations to the simple two-end member assumptions associated with the Keeling plot method (see e.g., Tans, 1998). On a global scale, the ¹⁸O isotopic content



Correspondence to: B. Tuzson
(bela.tuzson@empa.ch)

of CO₂ is mainly determined by the isotopic signature of the equilibrating water, which itself undergoes strong seasonal and latitudinal variations (Francey and Tans, 1987; Ciais et al., 1997). Thus, the atmospheric CO₂ is getting enriched in ¹⁸O by oxygen isotope exchange with ocean and leaf water, but depleted by exchange with soil water and by anthropogenic emission of CO₂ leading to a seasonal pattern with an amplitude of about 1.5‰ in the Northern Hemisphere (Ciais et al., 1997). It is generally assumed that the ¹⁸O signature of the CO₂ produced in combustion processes is equal to that of the atmospheric oxygen (Kroopnick and Craig, 1972). A mean δ¹⁸O value for all combustion-derived CO₂ of −17‰, is therefore considered in the recent carbon cycle isotope models (e.g., Ciais et al., 1997; Cuntz et al., 2003).

Here we demonstrate the feasibility of improving anthropogenic CO₂ source identification and characterization at large regional scales by using laser spectroscopy as on-line and in situ measurement technique. For this purpose, an instrument was designed and developed to perform high precision isotope ratio measurement of both δ¹³C and δ¹⁸O of atmospheric CO₂ at ambient mixing ratio. This spectrometer has been continuously measuring atmospheric CO₂ and its isotopic composition in real-time at the high Alpine observatory on Jungfraujoch that allows intermittent sampling of free tropospheric background air and polluted boundary layer influenced air. This CO₂ time-series together with the isotopic composition at high temporal resolution provide essential information for identification and characterization of pollution events, as presented in the following sections.

2 Experimental

2.1 Measurement site

The high Alpine research station Jungfraujoch (JFJ) is located in the western Swiss Alps on a mountain saddle at an altitude of 3580 m a.s.l. (46°33′ N, 7°59′ E). Given its high elevation and year-round accessibility, the station is an excellent place for long-term monitoring. Observations at JFJ are mostly representative of the free troposphere, particularly during autumn/winter when about 70% of the air masses can be characterized as undisturbed free tropospheric, 20% as free tropospheric but disturbed by synoptic uplift of polluted air, and only about 10% by more local uplift and convection (Zellweger et al., 2003). Furthermore, its central position within the European continent and its particular topographical condition offers the opportunity to investigate the transport of anthropogenic CO₂ from the highly industrialized surrounding regions to the free troposphere (Balzani Lööv et al., 2008; Forrer et al., 2000). Since JFJ is part of the Swiss National Air Pollution Monitoring Network (NABEL) and of the World Meteorological Organization Global Atmosphere Watch (WMO-GAW) programme, a large number of

trace gases and aerosol parameters are routinely monitored providing additional information for data interpretation.

2.2 Spectrometer setup

A detailed description of the instrumental design and signal processing has already been presented elsewhere (Nelson et al., 2008; Tuzson et al., 2008) and its field capability was demonstrated in several campaigns (Tuzson et al., 2008; Zeeman et al., 2009; Kammer et al., 2011). The spectrometer has a modular construction to provide easy transport and setup. The three main parts are: optical module, control electronics and an automated calibration unit. Briefly, a pulsed quantum cascade laser (QCL, Alpes Lasers, Switzerland) emitting at 2310 cm^{−1} is used as a mid-infrared light source and scanned at 3.7 kHz repetition rate over the absorption lines of the three CO₂ isotopic species. The beam is, after collimation, split in two parts of equal intensities and coupled into a dual-multipass cell assembly. This dual-cell arrangement allows for simultaneous sample/reference gas measurements which, since the sample mixing ratios are continually referenced to the stable isotope ratios of the reference gas, significantly improves the accuracy of the isotope ratio determination. Furthermore, uncertainties in the spectral fitting procedure are considerably reduced by applying the spectral analysis to the ratio of the sample and reference spectra. The simultaneous quantification of the three main CO₂ isotopologues (¹²C¹⁶O₂, ¹³C¹⁶O₂ and ¹²C¹⁶O¹⁸O) is done by a commercial software for spectral analysis and laser control (TDLWintel, Aerodyne Inc., USA). Employing thermoelectrically cooled infrared detectors (PVI-3TE-4.4, Vigo System, PL) and quasi-room temperature QCL, a completely cryogen-free operation is achieved, which facilitates unattended and long-term measurements.

The instrument performance in terms of detection limit and stability over time was characterized on the sampling site by applying the Allan variance technique (Werle et al., 1993). Mixing ratios of the individual CO₂ isotopologues were measured with one second time resolution from a compressed air cylinder over a one hour period. Short-term precision at one second was 0.29‰, for both ratios, and the associated Allan variance plots had a minimum at 50 s which corresponds to a relative precision of 0.046‰, for both δ¹³C and δ¹⁸O. For integration times beyond 50 s, the Allan plot showed a horizontal level up to 120 s and then an increasing variance indicated the presence of “drift” noise.

2.3 Sampling system and calibration method

The sampling and calibration system is schematically illustrated in Fig. 1. Air samples were drawn from the NABEL stainless steel main inlet (i.d. 8 cm, total length 3.1 m) where the air flow is maintained at 833 slpm and at a constant temperature of 10 °C. A heated and PTFE coated diaphragm vacuum pump (N036ST.26E, KNF, Germany) maintained a

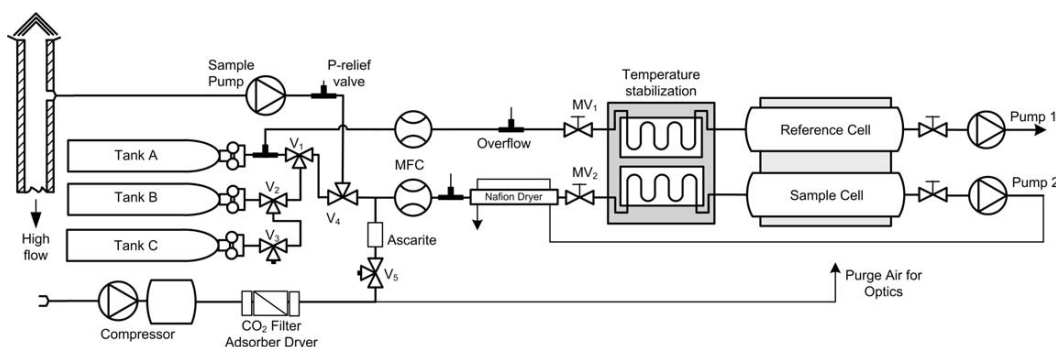

Fig. 1. Sampling setup of the QCLAS. V_i and MV_i are solenoid- and manual-valves, MFC-mass flow controller and Tank A, B, C are the calibration gases (see text for more details).

constant flow of 1 slpm through 15 m of stainless steel tubing (1/4 in), which conducted the air stream to the laser spectrometer. Afterwards, the air from the pump outlet was directed through a Nafion drier (PD-100T, Perma Pure, USA) to eliminate volumetric effects on mixing ratio determinations. Potentially, water vapour could also have an impact on the isotope ratio through collisional broadening (Tuzson et al., 2010). However, in this very specific case, the effect is likely to be small, because the pressure broadening coefficients for the main and minor CO₂ isotopic species at the investigated wavelength are very similar (Sung et al., 2006). A pressure relief valve was added between the pump outlet and the Nafion drier to avoid pressure build-up in the sampling line during calibration. Furthermore, a 0.5 L buffer volume was inserted to minimize pressure fluctuations due to the pump's pulsation. The air was then passed across a temperature stabilization module, a 7 μ m sintered metal filter and continuously drawn (0.4 slpm) through the multi-pass cell (sample side) at a pressure of 8 kPa by an oil free diaphragm vacuum pump (N920 series, KNF, Germany). The flow rates and pressures in both cells were adjusted and maintained stable by a combination of thermal mass flow controllers (Redy Smart series, Vögtlin Instruments, Switzerland) and low-flow metering valves (SS-SS6M, Swagelok, USA) at the cell inlet and on the downstream side, respectively. The instrument's sampling system periodically switched between air sample and calibration gases. The latter were measured as follows: (1) standard Tank A (every 15 min); (2) standard Tank B (every two hours); (3) standard Tank C (every 12 h). Each calibration gas was sampled for 300 s, except Tank A for which the sampling was set to 130 s. This cycling was applied to the sample cell only, while through the reference cell a continuous flow (0.08 slpm) of reference gas (Tank A) was maintained during the entire campaign.

The calibration gases used in this study were produced in our laboratory based on gravimetric and dynamic dilution methods. This process involved the mixing in various amounts of two pure CO₂ gases from distinctively different sources (marine carbonate and methane burning) and

their consecutive dilution by synthetic air. Finally, these special air mixtures were analyzed in the IsoLab at the Max-Planck Institute for Biogeochemistry (MPI-BGC, Jena, Germany). Their carbon and oxygen isotopic composition were determined by high precision isotope ratio mass spectrometer (IRMS) analysis and expressed as the relative difference of isotopic abundance ratio relative to the “Jena-Reference AirSet” (J-RAS) standard reference material (Ghosh et al., 2005). The absolute $\delta^{13}\text{C}$ and $\delta^{18}\text{O}$ value of the J-RAS is closely linked to the V-PDB (Vienna-PeeDee Belemnite) - scale and is used to serve as a primary scale anchor for CO₂-in-air measurements. The CO₂ mixing ratio of each tank was linked to the WMO mole fraction scale by gas chromatography (Agilent 6890 gas chromatograph equipped with a methanizer and a flame ionisation detector).

The instrumental response was previously characterized in the laboratory by using six calibration gases with CO₂ mixing ratios spanning the range of 384–1970 ppm and having isotopic compositions $\delta^{13}\text{C}$ of -4 to -37‰ and $\delta^{18}\text{O}$ of -5 to -29‰ , respectively. The linearity and potential accuracy of the instrument for isotope ratio measurements ($\delta^{13}\text{C}$ and $\delta^{18}\text{O}$) has been estimated to $\pm 0.06\text{‰}$ (1σ standard deviation), while the precision and accuracy of the CO₂ mixing ratio values are better than ± 0.03 ppm (after 50 s integration time corresponding to the Allan-variance minimum) and ± 0.1 ppm, respectively.

2.4 Backward Lagrangian particle dispersion simulations

The Lagrangian particle dispersion model (LPDM) FLEXPART (Stohl et al., 2005) was used in backward mode (Seibert and Frank, 2004) to characterize the source regions of the sampled air masses. The model was driven by 3-hourly European Center for Medium-range Weather Forecast (ECMWF) fields by alternating analyses and forecasts at $1^\circ \times 1^\circ \times 90$ levels resolution globally and at a higher resolution of $0.2^\circ \times 0.2^\circ$ for a nested domain covering central Europe to better represent the Alpine topography. For

every 3-h observation interval 50 000 “particles” were released from JFJ and traced back over 5 days. The particles were released at 3000 m a.s.l. which is a compromise between the model surface altitude (2170 m a.s.l.) and the real station height (3580 m a.s.l.). This choice is based on sensitivity tests with different release altitudes and on a comparison of specific humidity measurements at JFJ with vertical profiles acquired from routinely launched soundings at the nearby station Payerne (46.8° N, 6.9° E) over flat terrain. The best agreement with the sondes was found for an altitude of about 3000 m a.s.l. indicating that air reaching JFJ is experiencing significant uplift due to topographic effects which can not be resolved by the model. LPDMs provide a much more comprehensive view of the air-mass history than single trajectory models as they account for the dispersion of a retro-plume by turbulent motion and convection. For each simulation a “footprint” was computed, i.e. a map of the residence time of the particles within a layer of 100 m above ground. The footprint can be interpreted as a source sensitivity function (given in units of $\text{s m}^3 \text{kg}^{-1}$ (Seibert and Frank, 2004)): emission sources at places of high/low residence times have a high/low potential to have contributed to the observation. Finally, footprints of selected pollution or background measurement episodes were combined into single footprints to describe the general air mass origin during these periods.

3 Results and discussion

The very small variations in the isotopic composition of atmospheric CO₂ make their detection a challenging task. A back of the envelope estimate of the expected isotopic signal variability can be made as follows: the background tropospheric air has an approximate CO₂ content of 390 ppm (Northern Hemisphere, winter period, 2009) with an isotopic composition of $\delta^{13}\text{C} = -8.4\text{‰}$ and $\delta^{18}\text{O} = -0.3\text{‰}$, respectively. Assuming an additional admix of 10 ppm anthropogenic CO₂ originating from fossil fuel burning with an average $\delta^{13}\text{C}$ of -28‰ and $\delta^{18}\text{O}$ of -17‰ and applying the simple two source mixing model, this admix will induce a decrease of 0.5‰ and 0.4‰ in the measured $\delta^{13}\text{C}$ and $\delta^{18}\text{O}$ values, respectively. These signals are about twice the instrumental precision at one second resolution and 10 times higher than the achievable detection limit. The ability to generate a large number of data points at the highest possible precision is obviously necessary to maximize the constraints on the retrieved $\delta^{13}\text{C}$ and $\delta^{18}\text{O}$ values.

An objective estimate of the analyzer’s long-term stability and repeatability of the measurements was obtained by considering the retrieved values of the second standard gas (Tank B) after the calibration procedure was applied. Figure 2 shows the corresponding CO₂ mixing ratio and isotope ratio values (two minutes average) during a one month measurement period. The histogram plots indicate that the

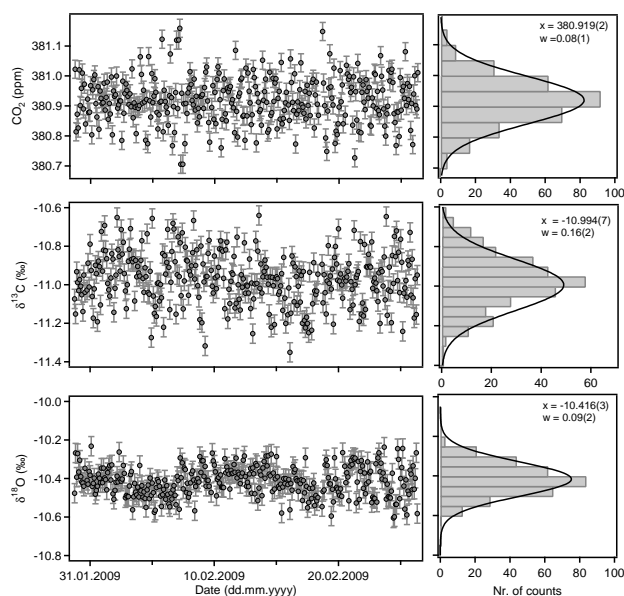

Fig. 2. Long term stability of the QCLAS. The data show repeated measurements of the secondary standard for February, 2009. The individual δ -values of each calibration step were plotted as a histogram with a 0.05‰ bin width.

data ($n = 324$) are nearly normally distributed. A Gaussian fit to the distributions suggests a long-term precision of the two minute averaged CO₂ mixing ratios and δ -values of about 0.08 ppm and $<0.2\text{‰}$, respectively. Since this describes the statistical uncertainty of single values, repeated measurements lead to an even lower error of the mean.

The laser spectrometer was installed at the JFJ research station in August 2008 and has been continuously delivering data at one second time resolution with a data availability of more than 96%. For this study, the analysis period was limited to one winter month (February, 2009) for two reasons: (1) the biological activity (photosynthesis/respiration) is presumably the smallest for this period of the year, thus, minimizing but not eliminating its effects on the interpretation of pollution signals and (2) within this period we captured several short-term pollution events associated with a variety of pronounced meteorological conditions including frontal lifting and South Foehn events typical for the situation at Jungfrauoch (Zellweger et al., 2003). These events induced a pronounced increase (≥ 10 ppm) in the measured CO₂ with a clearly detectable change in its isotopic composition. Moreover, these distinct meteorological conditions allowed us to spatially attribute emissions from the European continent by using the Lagrangian backward calculations and determine the footprint of the air masses.

High resolution time series of CO₂ mixing ratio and the corresponding $\delta^{13}\text{C}$ and $\delta^{18}\text{O}$ values are shown in Fig. 3. Since we are mainly interested in the pollution events rather than the short-term environmental fluctuations, the data

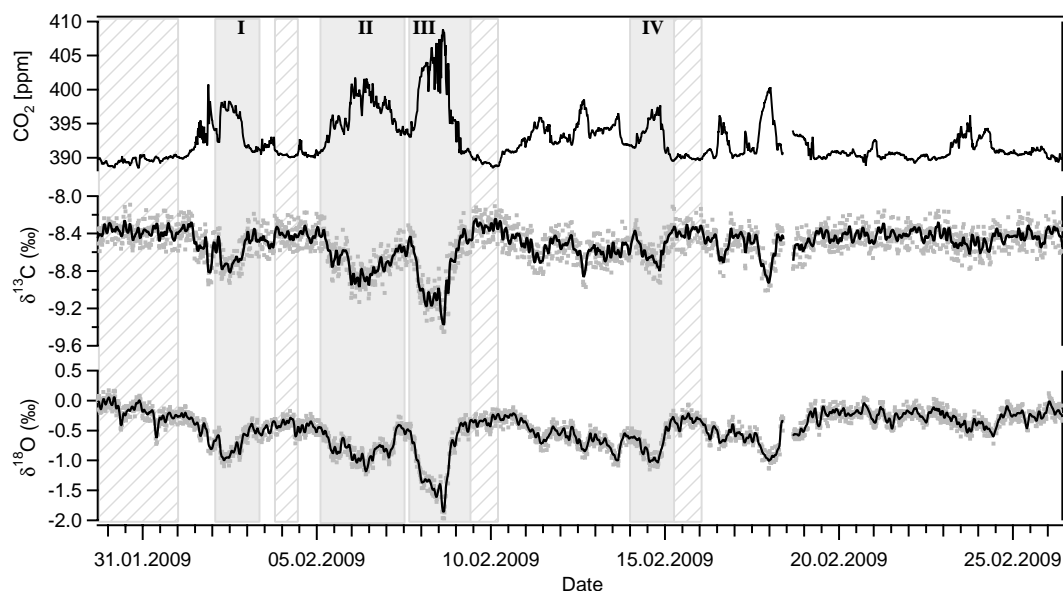

Fig. 3. Time series of tropospheric CO₂ mixing ratio and its isotopic composition. For the delta values, the gray dots represent 10 min averages, while the solid line is an interpolation through the data using a smooth spline. The shaded areas indicate distinct pollution events, while periods with the free tropospheric background conditions are highlighted by hatched areas.

points were averaged for 10 min, which is consistent with the sampling/calibration routine. While this results in a smooth curve for the CO₂ mixing ratio, the scatter is still significant at the permil scale, i.e. for $\delta^{13}\text{C}$ and $\delta^{18}\text{O}$. Therefore, an interpolation line using a smoothing spline algorithm (Igor Pro v6, Wavemetrics, Inc.) is added as visual aid for these parameters. The standard deviation parameter required by the algorithm was estimated to 0.09 and 0.07‰ for $\delta^{13}\text{C}$ and $\delta^{18}\text{O}$, respectively from the variability of the background air considered to characterize the noise in the time series accurately enough, so that the smoothing factor can be kept at the nominal value of one, thus avoiding any further smoothing of the data.

Several marked increases in CO₂ mixing ratios can be identified which point at frequent upward transport of air masses from the polluted boundary layer to Jungfraujoch in February 2009. These increases coincide partly with very low $\delta^{13}\text{C}$ and $\delta^{18}\text{O}$ values suggesting enhanced contributions from fossil fuel burning. In the following, four pollution episodes with distinct isotope signatures labelled I–IV in Fig. 3, are considered for further analysis. The analysis will be supported by measurements of carbon monoxide (CO) and FLEXPART footprints to characterize the sources in terms of origin and chemical signatures.

3.1 CO as proxy for fossil fuel CO₂

Fossil fuel emissions are the largest contributor to the CO burden in the Northern Hemisphere (Duncan et al., 2007). Given the relatively long atmospheric residence time of CO in winter of about a year (Holloway et al., 2000), it can be

used as a tracer for fossil fuel burning and hence for CO₂ emissions from regional combustion sources (Zondervan and Meijer, 1996; Gamnitzer et al., 2006; Turnbull et al., 2006, 2011; Levin and Karstens, 2007). Furthermore, the ratio between CO and CO₂ enhancements provides valuable information on the type of combustion since high ratios indicate poorly controlled, incomplete combustion processes. The mixing ratios of CO were measured continuously at the same site with a nondispersive infrared instrument (APMA-360, HORIBA Ltd.) as described by Zellweger et al. (2009). For all individual events mentioned above, CO correlated with CO₂ to a high degree ($r^2 > 0.9$) as shown in Fig. 4. Here, the orthogonal distance regression method was applied using the total CO mixing ratio and the CO₂ above tropospheric background (ΔCO_2), the latter being calculated as the difference between observed and background concentration level and referred to as combustion-derived CO₂. The background level was determined using low-pass filtering of the data (one year record) converted from the time domain into the frequency domain by a fast Fourier transformation. In this approach, the contribution of respired CO₂ from the biosphere is partly accounted for in the background air as a seasonal effect and the y-intercept given by the regression in Fig. 4 should represent the CO mixing ratios of continental background air for the specific season. In fact, the average value of the investigated one month period corresponds to 127 ± 1 ppb CO, which is in excellent agreement with the CO mole fractions of free tropospheric air when trends and seasonal variations are considered (e.g. see Fig. 6a in Zellweger et al., 2009). The correlation found for all selected

time periods is significant, with r^2 as high as 0.985. However, these tight correlations do not necessarily imply specific CO:CO₂ emission ratios. Since biogenic CO₂, originating mainly from above and underground respiration, can be co-transported with anthropogenic CO₂ preserving the tight correlations between fossil CO₂ and CO, a certain bias in the emission ratio cannot be excluded. However, the slope values of the regressions compare well with the results of tunnel measurements representing local traffic and transport on the Swiss highways, which report a vehicle weighted mean CO:CO₂ [ppb/ppm] ratio of 8 ± 3 linked to diesel and gasoline vehicles (Vollmer et al., 2007). It should also be mentioned that Vogel et al. (2010) report for Heidelberg, located in the industrialized upper Rhine valley in southwestern Germany, a winter time CO:CO₂ emission ratio of 13.5 ± 2.5 . This higher value could be indicative that the pollution events investigated in our study may contain significant (up to 20–40%) contribution from biogenic sources.

3.2 $\delta^{13}\text{C}$ and $\delta^{18}\text{O}$ as CO₂ source identifier

As outlined above, the stable isotope ratios $^{13}\text{C}/^{12}\text{C}$ and $^{18}\text{O}/^{16}\text{O}$ in the measured CO₂ are expected to contain information about the characteristics of the various pollution sources averaged over a regional scale. The pronounced short-term variations in CO₂ mixing ratio during the pollution events are well suited to utilize the Keeling plot method for deriving the isotopic composition of the pollution sources. In agreement with the simple mixing model developed by Keeling (1958), a plot of the measured $\delta^{13}\text{C}$ as a function of $1/[\text{CO}_2]$ gives a straight line relationship with the intercept representing the integrated measure of the isotopic composition of CO₂ emitted by a source ($\delta^{13}\text{C}_s$). At remote sites, the CO₂ variability is rather small, resulting in severe requirements regarding measurement stability, precision and number of data points to obtain a meaningful Keeling plot. These requirements can be met by the employed laser spectrometer, because its high temporal resolution results in a sufficiently large sample size per event to accurately capture the tiny changes in the atmospheric CO₂ and provide a more robust estimate for the intercept value.

The average $\delta^{13}\text{C}_s$ signature of the regional pollution sources was calculated based on the above mentioned two-component mixing method. In Fig. 5, the correlation of the measured $\delta^{13}\text{C}$ and the inverse of CO₂ mixing ratio is individually shown for each event. The data points are one hour aggregates of the measured quantities recorded at one second temporal resolution. As such, they are not single-point measurements, but rather contain the continuous information of the whole averaging period. The intercept values range between -27 and -30‰ , while the averaged value for the whole time-series in February 2009 was $-28.3 \pm 0.2\text{‰}$, ($r^2 = 0.91$). They agree well with existing isotope ratio measurements of tropospheric CO₂ above Europe from aircraft sampling (Friedli et al., 1987; Zahn et al., 2000; Levin et al.,

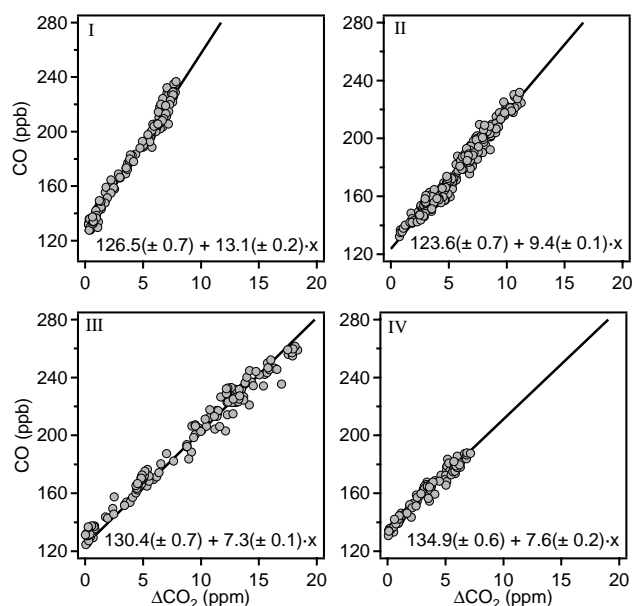

Fig. 4. Scatter plot of CO versus CO₂ above background (ΔCO_2) for the four selected pollution events. The linear fit results with the 1σ uncertainty (in parentheses) are also given. Since absolute CO mixing ratios are used, the intercept of the regression corresponds to the continental background CO level. The slope is indicative for the combustion process.

2002; Assonov et al., 2010). Furthermore, it is tempting to say that the range of isotopic signatures across events could represent geographic variability in fuel mixtures, likely a variable amount of natural gas combustion. However, a clear distinction between various types of combustion processes is hindered by the same complexity as mentioned in the case of CO and CO₂ correlation. Similarly, the Keeling plot intercepts probably reflect a combination of anthropogenic and biological sources, thus giving biased (by up to 2‰) apparent source signatures.

The low $\delta^{13}\text{C}_s$ values during all events are, however, consistent with combustion sources. $\delta^{13}\text{C}$ values reported for different combustion sources are on the order of -24‰ , for coal, -30‰ , to -26‰ , for oil, -44‰ , for natural gas and -27‰ , to -22‰ , for combustion of wood (Ciais et al., 1995; Andres et al., 1999; Schulze et al., 2004). The low values of events II, III and IV thus suggest a major contribution from oil combustion while the higher value of event I would again (see Fig. 4) be consistent with a substantial contribution from coal or biomass/wood burning.

While the measured carbon isotope data resulted in plausible estimates for anthropogenic CO₂ sources, the oxygen isotope of the atmospheric CO₂ is influenced by complex interactions involving both biotic and abiotic processes. Moreover, the equilibration process between oxygen isotopes of atmospheric CO₂ and of water proceeds without any net flux of CO₂ and depends on many meteorological variables

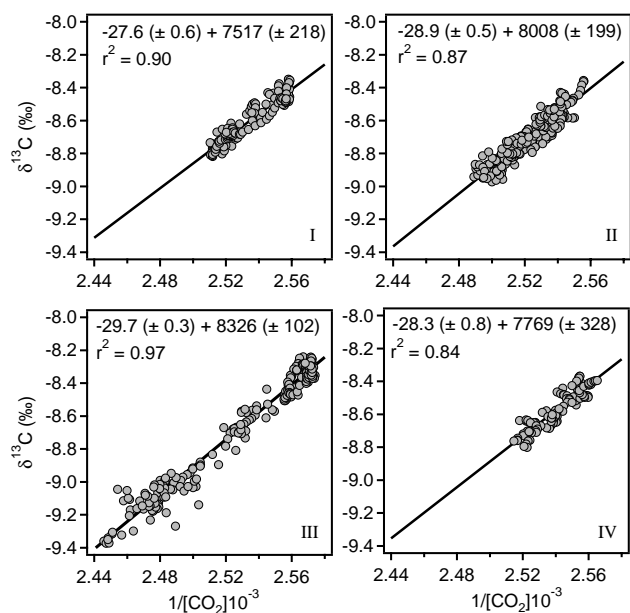

Fig. 5. Keeling plots for data collected during the individual pollution events. $\delta^{13}\text{C}$ values representing one hour aggregates are plotted against the inverse of CO₂ mixing ratio. The intercept and the slope of the ordinary least square linear regression is given together with their 1σ uncertainties.

(Francey and Tans, 1987; Farquhar et al., 1993; Ciais et al., 1997). During winter, when the photosynthetic contribution (i.e. the amount of CO₂ isotopically exchanged with leaf water) can be neglected, all the remaining sources, which are primarily due to interaction with soils and release of anthropogenic CO₂, tend to deplete atmospheric CO₂ in ¹⁸O, and $\delta^{18}\text{O}$ source signatures of -23% , are readily possible (Miller et al., 1999). Although, the $\delta^{18}\text{O}$ follows a Keeling relation, the signatures of the "sources" determined from the linear regression are as low as -36% . Even though similar low $\delta^{18}\text{O}$ -values (-34%) occurring in wintertime were measured by IRMS in Bern, Switzerland (Sturm et al., 2006), they cannot be interpreted as the oxygen isotopic composition of CO₂ released by any known source. These values reflect the limitation of the two source mixing assumption for $\delta^{18}\text{O}$, due to the effect of oxygen isotopic exchange without concentration changes. In this case, the Keeling relation can only give the $\delta^{18}\text{O}$ signature of an apparent instead of a real source.

The challenge then becomes to estimate the amount of CO₂ that was involved in oxygen isotopic exchange with soil water. As suggested by Tans (1998), in areas of low biological productivity a back-diffusion flux of CO₂ may become the major influence on $\delta^{18}\text{O}$ of atmospheric CO₂. According to this, a certain amount of CO₂ enters the soil from the air, equilibrates with soil water and leaves the soil again through diffusion. This process, also called invasion, is not associated with any net flux of CO₂ in or out of the soil. The $\delta^{18}\text{O}_s$ of CO₂ released by soils is mainly dependent on the oxy-

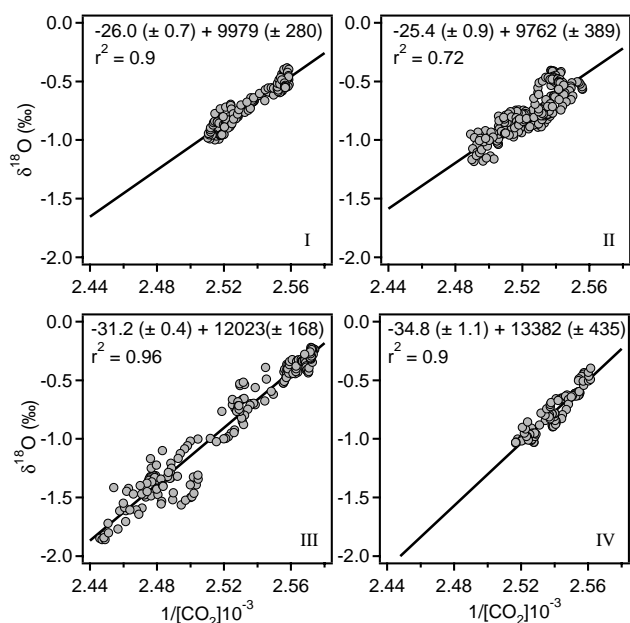

Fig. 6. Keeling plots for data collected during the individual pollution events. $\delta^{18}\text{O}$ values representing one hour aggregates are plotted against the inverse of CO₂ mixing ratio. The intercept and the slope of the ordinary least square linear regression is given together with their 1σ uncertainties.

gen isotope composition of soil water which approximately matches that of ground water. Thus, we are able not only to explain our results, but also make a quantitative estimate for the amount of invasion CO₂ required to match the observations. For this, we need first the $\delta^{18}\text{O}$ in soil water at regional scale. A mean value for the ¹⁸O isotope distribution in soil water can be provided by the correlation between the seasonal evolution of $\delta^{18}\text{O}$ in precipitation and air temperature. In fact, the $\delta^{18}\text{O}$ value in VSMOW (Vienna Standard Mean Ocean Water) can be estimated from a linear regression (Rozanski et al., 1982, 1992; Schürch et al., 2003)

$$\delta^{18}\text{O} = 0.59 T(^{\circ}\text{C}) - 14.3 \quad (1)$$

of air temperature. Moreover, the temperature dependent value for the equilibrium fractionation factor ϵ_{eq} between the oxygen in CO₂ and water is given by (Brenninkmeijer et al., 1983)

$$\epsilon_{\text{eq}} = 17\,604/T(\text{K}) - 17.93 \quad (2)$$

By taking an average ambient temperature of 0°C, the ¹⁸O/¹⁶O isotope ratio of soil water is given by Eq. (1) as -14.3% , versus VSMOW or -53.6% , versus VPDB-CO₂. Similarly, the fractionation factor for isotopically exchanged CO₂ is determined from Eq. (2) to be $+46.6\%$, versus VPDB-CO₂. When this CO₂ diffuses out of the soil, it undergoes a kinetic isotope fractionation with a maximum value of -8.7% , but the disequilibrium between CO₂ and water near

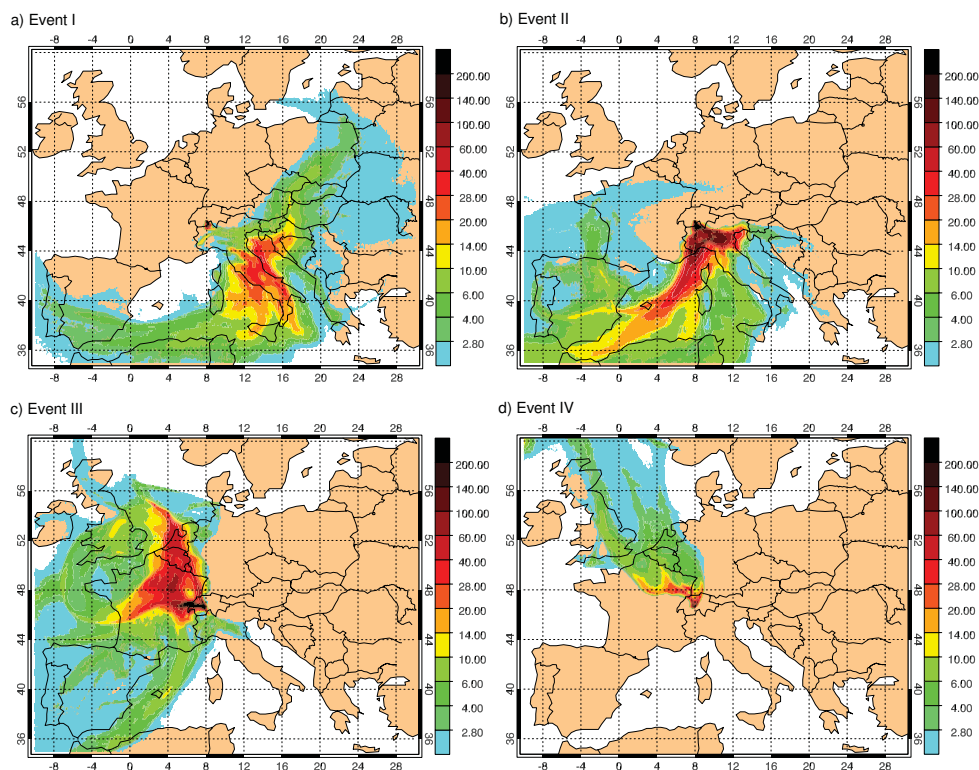

Fig. 7. Backward LPDM calculations, showing the potential source regions (surface footprints) of air-masses reaching JFJ during pollution events. Yellow to red colors ($\text{s kg}^{-1} \text{m}^3$) identify regions from which elevated CO₂ potentially originated.

the surface results in a effective global mean fractionation value of about -7.2‰ , (Miller et al., 1999). Hence, the signature of the back-diffused CO₂ ($\delta^{18}\text{O}_{\text{inv}}$) is about -14.2‰ , which is more negative than the atmospheric air. Very similar results (-15‰) were reported earlier by Hesterberg and Siegenthaler (1991) for soil air samples. The obtained low $\delta^{18}\text{O}_s$ values of the Keeling plot can readily be explained by assuming certain amounts of invasion CO₂ admixed in the atmospheric background air with $\delta^{18}\text{O}_{\text{bkg}} \approx 0\text{‰}$. The amount of invasion CO₂ (C_{inv}) can be estimated using a simple isotopic mass balance calculation

$$\delta^{18}\text{O}_m C_m = \delta^{18}\text{O}_{\text{bkg}} C_{\text{bkg}} + \delta^{18}\text{O}_c C_c + \delta^{18}\text{O}_{\text{inv}} C_{\text{inv}} \quad (3)$$

where C_m , C_{bkg} , C_c and C_{inv} are the measured, background, combustion-derived and invasion CO₂ mixing ratios. By making the plausible assumption that the measured CO₂ mixing ratio increase is merely due to anthropogenic pollution caused by fossil fuel burning (i.e. $C_c = \Delta\text{CO}_2$) with a $\delta^{18}\text{O}_c$ value similar to the theoretical value for the oxygen isotope ratio of combustion of -17‰ , (Kroopnick and Craig, 1972), the only unknown parameter in Eq. (3) is C_{inv} . Substituting the values for the other parameters results in C_{inv} peak values of about 16 ppm for the pollution events I and II, while for event III the amount is about 28 ppm. As one might expect, the amount of C_{inv} can differ from case to case depending on meteorological factors and soil conditions which influence

the time available for atmospheric CO₂ to diffuse into the soil, react, and equilibrate isotopically with soil water. Ultimately, the C_{inv} should be related to the amount of time that the air masses have been spend in the proximity of the ground before reaching JFJ. This hypothesis will be discussed based on the results of the next Section.

3.3 Backward LPDM calculations as source region identifier

Backward Lagrangian particle dispersion modeling is a powerful tool to identify the origin and transport pathways of the air arriving at a receptor site and thus efficiently complements the data analysis presented so far. As shown above, events II, III and IV have very similar $\delta^{13}\text{C}_s$ and CO:CO₂ ratio values and will thus be discussed first. The surface footprint for event II (Fig. 7b) indicates transport from South and South-East to JFJ over the highly industrialized Po Valley in Northern Italy. Pollutants from this region were entrained into the boundary layer and later transported in a South Foehn episode to JFJ. Foehn is an airflow that only develops in mountainous regions and it is an effective mechanism for rapid vertical transport and mixing of boundary layer air. For event III the air masses were arriving at JFJ from the North-West during a short North Foehn episode (Fig. 7c). Surface contact was indicated over western Switzerland, eastern

France and the Benelux region. This is in excellent agreement with the observed CO₂ characteristics: a large increase in the mixing ratio which strongly correlates with the CO and having a depleted ¹³C content of −30‰, (as determined from the Keeling plot approach, Fig. 5), common to fossil fuel burning. In the case of event IV, one would expect from the CO vs. CO₂ relation a similar combustion process. This is further supported by the intercept value ($\delta^{13}\text{C}_s$) on the Keeling plot. However, the rather small CO₂ mixing ratio changes and the accentuated spread in the $\delta^{13}\text{C}$ -values make an accurate intercept determination difficult. Nevertheless, the surface footprint (Fig. 7d) shows that the air-masses mainly had surface contact over eastern France, Belgium and to a smaller degree over western Germany. The general weather situation during this period was cold air advection from the North in which small convective precipitation systems were embedded that enabled vertical transport of air from surface emissions.

Event I was triggered by a South Foehn, similarly to event II. However, the surface footprint for this episode (see Fig. 7a) indicates a very localized source area at the southern foot of the Western Alps rather than covering the whole Po Valley. More spread out surface sensitivity was observed for the less polluted central and southern Italy and the adjacent maritime regions. The area of strong emission sensitivity corresponds to the upper Valais region in Switzerland and the Osella valley in Italy. In winter time, residential wood burning for heating purposes is common in these Alpine valleys, especially in the villages, and has a dominant impact on air pollution (Szidat et al., 2007; Saurer et al., 2009; Perron et al., 2010). The wood burning as a major contributor to the observed CO₂ increase fits well with the observations: the steeper CO:CO₂ slope (0.013) and the $\delta^{13}\text{C}$ Keeling plot intercept (−27.4‰).

Finally, in addition to the localization of potential source regions, LPDM calculations can also be used to estimate the total residence time of the air-masses close to the ground and relate them to the hypothesis of CO₂ invasion process discussed above. In fact, the calculated residence time in the boundary layer (Fig. 8) is qualitatively consistent with the estimated amount of CO₂ which went through the invasion process. As expected, longer residence times resulted in enhanced invasion. The averaged value of CO₂ interacting with soil for the whole period of February 2009 was estimated to 8.5 ± 5.4 ppm, which represents about 2% of the atmospheric CO₂. In the case of longer residence time of the air-masses close to the ground, the amount of CO₂ interacting with soil can be as high as 15–30 ppm CO₂, or 4–8% of atmospheric CO₂. This is consistent with values from literature, where the amount of atmospheric CO₂ that globally undergoes such invasion was estimated to be larger than the current annual fossil fuel combustion (Stern et al., 2001). Tans (1998) estimated a global CO₂ invasion of roughly 20% of the atmospheric column, while Cuntz et al. (2003) calculated a global CO₂ invasion flux of 18.6 GtC yr^{−1} with a global 3-D model of ¹⁸O-CO₂.

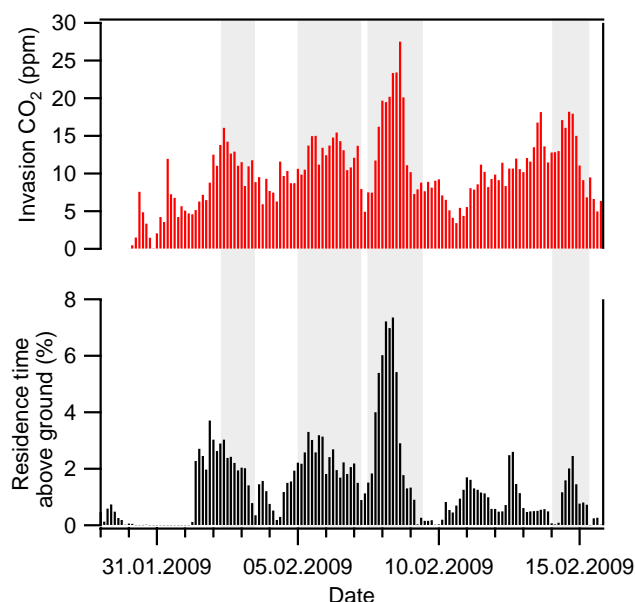

Fig. 8. Top panel indicates the amount of atmospheric CO₂ which exchanged its oxygen isotope with soil water (for details see text). Bottom panel shows the total residence time of the air-masses in a layer up to 100 m above ground relative to total residence time (5-days) as calculated from the LPDM at 4 h time intervals.

4 Conclusions

This paper is the first demonstration of long-term, in situ and high precision isotope measurements of CO₂ under free tropospheric conditions at a high altitude site by laser absorption spectroscopy. The instrument has been operating unattended in the field and providing continuous, high temporal resolution measurements of ¹²CO₂, ¹³CO₂ and ¹⁶O¹²C¹⁸O. The advantage of continuous data is well illustrated by the presented one month measurement period with distinct pollution events. Considerable temporal variation in the isotopic composition of atmospheric CO₂, even during the course of a single day were successfully recorded. Capturing this variation with flask sampling and mass spectrometry would be impractical. Furthermore, the high temporal resolution of the QCLAS led to well constrained $\delta^{13}\text{C}_s$ values for regional emission sources. The combination of four different types of information, i.e. CO:CO₂ correlation, the $\delta^{13}\text{C}_s$ and $\delta^{18}\text{O}_s$ signatures determined by the Keeling plot approach and LPDM calculations, allowed for a consistent identification, characterization and spatial attribution of four distinct pollution events. We were able to explain the observed variations in the atmospheric CO₂ mixing ratio by anthropogenic emissions with major contribution from fossil-fuel burning related to traffic, road-transport and residential heating. Air masses polluted with combustion derived CO₂ arriving at Jungfraujoch originated mainly from northern Italy, eastern France, Benelux region and southern Germany, as well as

from the local Alpine valleys of southern Switzerland. In addition, our data revealed that $\delta^{18}\text{O}$, despite its complex nature, is a promising tool to assess the oxygen isotope exchange between atmospheric CO₂ and soil water. We suggest that the measured atmospheric $\delta^{18}\text{O}$ values are strongly influenced by the invasion process and, therefore, the apparent $\delta^{18}\text{O}_s$ signatures may be used for experimental quantification of this effect at regional scales. The invasion hypothesis is supported by two factors: (i) the estimated amount of CO₂ interacting with soil is consistent with values from the literature, and (ii) the expected dependence on the residence time of the air-masses above ground is confirmed by independent calculations based on a particle dispersion model.

The one month high precision measurements presented in this paper illustrate the reliability of the employed spectroscopic technique and the potential of such time series. More extended analysis of several years of data will, however, be necessary to capture interannual and seasonal variations of atmospheric CO₂, and to obtain more robust statistics for the characterization of various regional CO₂ sources.

Acknowledgements. We thank the International Foundation High Altitude Research Station Jungfrauoch and Gornergrat (HFSJG) for access to JFJ facilities and on-site support. Funding was provided by the Swiss NCCR-Quantum Photonics, the Swiss Federal Office for the Environment (FOEN) and the Swiss National Science Foundation. Calibration gases were analyzed within the Transnational Access (TA1) activity of the IMECC (Infrastructure for Measurements of the European Carbon Cycle) project.

Edited by: R. Harley

References

- Andreae, M. O. and Merlet, P.: Emission of trace gases and aerosols from biomass burning, *Global Biogeochem. Cy.*, 15, 955–966, doi:10.1029/2000GB001382, 2001.
- Andres, R. J., Fielding, D. J., Marland, G., Boden, T. A., Kumar, N., and Kearney, A. T.: Carbon dioxide emissions from fossil-fuel use, 1751–1950, *Tellus B*, 51, 759–765, doi:10.1034/j.1600-0889.1999.t01-3-00002.x, 1999.
- Archer, D., Eby, M., Brovkin, V., Ridgwell, A., Cao, L., Mikolajewicz, U., Caldeira, K., Matsumoto, K., Munhoven, G., Montenegro, A., and Tokos, K.: Atmospheric lifetime of fossil fuel carbon dioxide, *Annu. Rev. Earth Pl. Sc.*, 37, 117–134, doi:10.1146/annurev.earth.031208.100206, 2009.
- Assonov, S. S., Brenninkmeijer, C. A. M., Schuck, T. J., and Taylor, P.: Analysis of ¹³C and ¹⁸O isotope data of CO₂ in CARIBIC aircraft samples as tracers of upper troposphere/lower stratosphere mixing and the global carbon cycle, *Atmos. Chem. Phys.*, 10, 8575–8599, doi:10.5194/acp-10-8575-2010, 2010.
- Balzani Lööv, J. M., Henne, S., Legreid, G., Staehelin, J., Reimann, S., Prévôt, A. S. H., Steinbacher, M., and Vollmer, M. K.: Estimation of background concentrations of trace gases at the Swiss Alpine site Jungfrauoch (3580 m asl), *J. Geophys. Res.*, 113, 1–17, doi:10.1029/2007JD009751, 2008.
- Boden, T. A., Marland, G. and Andres R. J.: Global, Regional, and National Fossil-Fuel CO₂ Emissions. Carbon Dioxide Information Analysis Center, Oak Ridge National Laboratory, U.S. Department of Energy, Oak Ridge, Tenn., USA, doi:10.3334/CDIAC/00001, 2010.
- Brenninkmeijer, C. A. M., Kraft, P., and Mook, W. G.: Oxygen isotope fractionation between CO₂ and H₂O, *Isot. Geosci.*, 1, 181–190, doi:10.1016/S0009-2541(83)80015-1, 1983.
- Ciais, P., Tans, P. P., White, J. W. C., Trolier, M., Francey, R. J., Berry, J. A., Randall, D. R., Sellers, P. J., Collatz, G. J., and Schimel, D. S.: Partitioning of ocean and land uptake of CO₂ as inferred by $\delta^{13}\text{C}$ measurements from the NOAA Climate Monitoring and Diagnostics Laboratory Global Air Sampling Network, *J. Geophys. Res.*, 100, 5051–5070, doi:10.1029/94JD02847, 1995.
- Ciais, P., Denning, A. S., Tans, P. P., Berry, J. A., Randall, D. A., Collatz, G. J., Sellers, P. J., White, J. W. C., Trolier, M., Meijer, H. A. J., Francey, R. J., Monfray, P., and Heimann, M.: A three-dimensional synthesis study of $\delta^{18}\text{O}$ in atmospheric CO₂ 1. Surface fluxes, *J. Geophys. Res.*, 102, 5857–5872, doi:10.1029/96JD02360, 1997.
- Conway, T. J., Tans, P. P., Waterman, L. S., Thoning, K. W., Kitzis, D. R., Masarie, K., and Zhang, N.: Evidence for interannual variability of the carbon cycle from the National Oceanic and Atmospheric Administration/Climate Monitoring and Diagnostics Laboratory Global Air Sampling Network, *J. Geophys. Res.*, 99, 22831–22855, doi:10.1029/94JD01951, 1994.
- Cuntz, M., Ciais, P., Hoffmann, G., Allison, C. E., Francey, R. J., Knorr, W., Tans, P. P., White, J. W. C., and Levin, I.: A comprehensive global three-dimensional model of $\delta^{18}\text{O}$ in atmospheric CO₂: 2. Mapping the atmospheric signal, *J. Geophys. Res.*, 108(D17), 4528, doi:10.1029/2002JD003154, 2003.
- Duncan, B. N., Logan, J. A., Bey, I., Megretskaja, I. A., Yantosca, R. M., Novelli, P. C., Jones, N. B., and Rinsland, C. P.: Global budget of CO, 1988–1997: Source estimates and validation with a global model, *J. Geophys. Res.*, 112, D22301, doi:10.1029/2007JD008459, 2007.
- Farquhar, G. D., Lloyd, J., Taylor, J. A., Flanagan, L. B., Syvertsen, J. P., Hubick, K. T., Wong, S. C., and Ehleringer, J. R.: Vegetation effects on the isotope composition of oxygen in atmospheric CO₂, *Nature*, 363, 439–443, doi:10.1038/363439a0, 1993.
- Forrer, J., Rüttimann, R., Schneiter, D., Fischer, A., Buchmann, B., and Hofer, P.: Variability of trace gases at the high-Alpine site Jungfrauoch caused by meteorological transport processes, *J. Geophys. Res.*, 105, 12241–12251, doi:10.1029/1999JD901178, 2000.
- Francey, R. J. and Tans, P. P.: Latitudinal variation in oxygen-18 of atmospheric CO₂, *Nature*, 327, 495–497, doi:10.1038/327495a0, 1987.
- Francey, R. J., Tans, P. P., Allison, C. E., Enting, I. G., White, J. W. C., and Trolier, M.: Changes in oceanic and terrestrial carbon uptake since 1982, *Nature*, 373, 326–330, doi:10.1038/373326a0, 1995.
- Friedli, H., Siegenthaler, U., Rauber, D., and Oeschger, H.: Measurements of concentration, ¹³C/¹²C and ¹⁸O/¹⁶O ratios of tropospheric carbon dioxide over Switzerland, *Tellus B*, 39, 80–88, doi:10.1111/j.1600-0889.1987.tb00272.x, 1987.
- Gamitzer, U., Karstens, U., Kromer, B., Neubert, R. E. M., Meijer, H. A. J., Schroeder, H., and Levin, I.: Carbon monoxide: A quantitative tracer for fossil fuel CO₂?, *J. Geophys. Res.*, 111, 1–19, doi:10.1029/2005JD006966, 2006.

- Ghosh, P., Patecki, M., Rothe, M., and Brand, W. A.: Calcite-CO₂ mixed into CO₂-free air: a new CO₂-in-air stable isotope reference material for the VPDB scale, *Rapid Commun. Mass Sp.*, 19, 1097–1119, doi:10.1002/rcm.1886, 2005.
- Hesterberg, R. and Siegenthaler, U.: Production and stable isotopic composition of CO₂ in a soil near Bern, Switzerland, *Tellus B*, 43, 197–205, doi:10.1034/j.1600-0889.1991.00013.x, 1991.
- Holloway, T., Levy II, H. and Kasibhatla, P.: Global distribution of carbon monoxide, *J. Geophys. Res.*, 105, 12123–12147, doi:10.1029/1999JD901173, 2000.
- Kammer, A., Tuzson, B., Emmenegger, L., Knohl, A., Mohn, J., and Hagedorn, F.: Application of a quantum cascade laser-based spectrometer in a closed chamber system for real-time δ¹³C and δ¹⁸O measurements of soil-respired CO₂, *Agric. Forest Meteorol.*, 151, 39–48, doi:10.1016/j.agrformet.2010.09.001, 2011.
- Keeling, C. D.: The concentration and isotopic abundances of atmospheric carbon dioxide in rural areas, *Geochim. Cosmochim. Ac.*, 13, 322–334, 1958.
- Keeling, C. D., Whorf, T. P., Wahlen, M., and Plicht, J.: Interannual extremes in the rate of rise of atmospheric carbon dioxide since 1980, *Nature*, 375, 666–670, doi:10.1038/375666a0, 1995.
- Kroopnick, P. and Craig, H.: Atmospheric oxygen: isotopic composition and solubility fractionation, *Science*, 175, 54–55, doi:10.1126/science.175.4017.54, 1972.
- Levin, I. and Karstens, U.: Inferring high-resolution fossil fuel CO₂ records at continental sites from combined ¹⁴CO₂ and CO observations, *Tellus B*, 59, 245–250, doi:10.1111/j.1600-0889.2006.00244.x, 2007.
- Levin, I., Ciais, P., Langenfelds, R., Schmidt, M., Ramonet, M., Sidorov, K., Tchepakova, N., Gloor, M., Heimann, M., Schulze, E. D., Vygodskaya, N. N., Shibistova, O., and Lloyd, J.: Three years of trace gas observations over the EuroSiberian domain derived from aircraft sampling – A concerted action, *Tellus B*, 54, 696–712, doi:10.1034/j.1600-0889.2002.01352.x, 2002.
- Miller, J. B., Yakir, D., White, J. W. C., and Tans, P. P.: Measurement of ¹⁸O/¹⁶O in the soil-atmosphere CO₂ flux, *Global Biogeochem. Cy.*, 13, 761–774, doi:10.1029/1999GB900028, 1999.
- Nelson, D. D., McManus, J. B., Herndon, S. C., Zahniser, M. S., Tuzson, B., and Emmenegger, L.: New method for isotopic ratio measurements of atmospheric carbon dioxide using a 4.3 μm pulsed quantum cascade laser, *Appl. Phys. B-Lasers O.*, 90, 301–309, doi:10.1007/s00340-007-2894-1, 2008.
- Pataki, D. E., Bowling, D. R., and Ehleringer, J. R.: Seasonal cycle of carbon dioxide and its isotopic composition in an urban atmosphere: Anthropogenic and biogenic effects, *J. Geophys. Res.*, 108, 4735–4743, doi:10.1029/2003JD003865, 2003.
- Perron, N., Sandradewi, J., Alfarra, M. R., Lienemann, P., Gehrig, R., Kasper-Giebl, A., Lanz, V. A., Szidat, S., Ruff, M., Fahrni, S., Wacker, L., Baltensperger, U., and Prévôt, A. S. H.: Composition and sources of particulate matter in an industrialised Alpine valley, *Atmos. Chem. Phys. Discuss.*, 10, 9391–9430, doi:10.5194/acpd-10-9391-2010, 2010.
- Randerson, J. T., Thompson, M. V., Conway, T. J., Fung, I. Y., and Field, C. B.: The contribution of terrestrial sources and sinks to trends in the seasonal cycle of atmospheric carbon dioxide, *Global Biogeochem. Cy.*, 11, 535–560, doi:10.1029/97GB02268, 1997.
- Rozanski, K., Sonntag, C., and Münnich, K. O.: Factors controlling stable isotope composition of European precipitation, *Tellus B*, 34, 142–150, doi:10.1111/j.2153-3490.1982.tb01801.x, 1982.
- Rozanski, K., Araguás-Araguás, L., and Gonfiantini, R.: Relation between long-term trends of oxygen-18 isotope composition of precipitation and climate, *Science*, 258, 981–985, doi:10.1126/science.258.5084.981, 1992.
- Saurer, M., Prévôt, A. S. H., Dommen, J., Sandradewi, J., Baltensperger, U., and Siegwolf, R. T. W.: The influence of traffic and wood combustion on the stable isotopic composition of carbon monoxide, *Atmos. Chem. Phys.*, 9, 3147–3161, doi:10.5194/acp-9-3147-2009, 2009.
- Schulze, B., Wirth, C., Linke, P., Brand, W., Kuhlmann, I., Horna, V., and Schulze, E. D.: Laser ablation-combustion-GC-IRMS – A new method for online analysis of intra-annual variation of δ¹³C in tree rings, *Tree Physiol.*, 24, 1193–1201, 2004.
- Schürch, M., Kozel, R., Schotterer, U., and Tripet, J. P.: Observation of isotopes in the water cycle – The Swiss National Network (NISOT), *Environ. Geol.*, 45, 1–11, doi:10.1007/s00254-003-0843-9, 2003.
- Seibert, P. and Frank, A.: Source-receptor matrix calculation with a Lagrangian particle dispersion model in backward mode, *Atmos. Chem. Phys.*, 4, 51–63, doi:10.5194/acp-4-51-2004, 2004.
- Stern, L. A., Amundson, R., and Baisden, W. T.: Influence of soils on oxygen isotope ratio of atmospheric CO₂, *Global Biogeochem. Cy.*, 15, 753–759, doi:10.1029/2000GB001373, 2001.
- Stohl, A., Forster, C., Frank, A., Seibert, P., and Wotawa, G.: Technical note: The Lagrangian particle dispersion model FLEXPART version 6.2, *Atmos. Chem. Phys.*, 5, 2461–2474, doi:10.5194/acp-5-2461-2005, 2005.
- Sturm, P., Leuenberger, M., Valentino, F. L., Lehmann, B., and Ihly, B.: Measurements of CO₂, its stable isotopes, O₂/N₂, and ²²²Rn at Bern, Switzerland, *Atmos. Chem. Phys.*, 6, 1991–2004, doi:10.5194/acp-6-1991-2006, 2006.
- Sung, K., Brown, L. R., Toth, R. A., and Crawford, T. J.: Fourier transform infrared spectroscopy measurements of H₂O-broadened half-widths of CO₂ at 4.3 μm, *Can. J. Phys.*, 87, 469–484, doi:10.1139/P08-130, 2009.
- Szidat, S., Prévôt, A. S. H., Sandradewi, J., Alfarra, M. R., Sznajder, H. A., Wacker, L., and Baltensperger, U.: Dominant impact of residential wood burning on particulate matter in Alpine valleys during winter, *Geophys. Res. Lett.*, 34, L05820, doi:10.1029/2006GL028325, 2007.
- Tans, P. P.: Oxygen isotopic equilibrium between carbon dioxide and water in soils, *Tellus B*, 50, 163–178, doi:10.1034/j.1600-0889.1998.t01-1-00004.x, 1998.
- Tans, P. P., Conway, T. J., and Nakazawa, T.: Latitudinal Distribution of the Sources and Sinks of Atmospheric Carbon Dioxide Derived From Surface Observations and an Atmospheric Transport Model, *J. Geophys. Res.*, 94, 5151–5172, doi:10.1029/JD094iD04p05151, 1989.
- Turnbull, J. C., Miller, J. B., Lehman, S. J., Tans, P. P., Sparks, R. J., and Southon, J.: Comparison of ¹⁴CO₂, CO, and SF₆ as tracers for recently added fossil fuel CO₂ in the atmosphere and implications for biological CO₂ exchange, *Geophys. Res. Lett.*, 33, L01817, doi:10.1029/2005GL024213, 2006.
- Turnbull, J. C., Karion, A., Fischer, M. L., Faloona, I., Gundersen, T., Lehman, S. J., Miller, B. R., Miller, J. B., Montzka, S., Sherwood, T., Saripalli, S., Sweeney, C., and Tans, P. P.: Assessment of fossil fuel carbon dioxide and other anthropogenic trace gas emissions from airborne measurements over Sacramento,

- California in spring 2009, *Atmos. Chem. Phys.*, 11, 705–721, doi:10.5194/acp-11-705-2011, 2011.
- Tuzson, B., Mohn, J., Zeeman, M. J., Werner, R. A., Eugster, W., Zahniser, M. S., Nelson, D. D., McManus, J. B., and Emmenegger, L.: High precision and continuous field measurements of $\delta^{13}\text{C}$ and $\delta^{18}\text{O}$ in carbon dioxide with a cryogen-free QCLAS, *Appl. Phys. B-Laser O.*, 92, 451–458, doi:10.1007/s00340-008-3085-4, 2008.
- Tuzson, B., Hiller, R. V., Zeyer, K., Eugster, W., Neftel, A., Ammann, C., and Emmenegger, L.: Field intercomparison of two optical analyzers for CH₄ eddy covariance flux measurements, *Atmos. Meas. Tech.*, 3, 1519–1531, doi:10.5194/amt-3-1519-2010, 2010.
- Vogel, F. R., Hammer, S., Steinhof, A., Kromer, B., and Levin, I.: Implication of weekly and diurnal ¹⁴C calibration on hourly estimates of CO-based fossil fuel CO₂ at a moderately polluted site in southwestern Germany, *Tellus B*, 62, 512–520, doi:10.1111/j.1600-0889.2010.00477.x, 2010.
- Vollmer, M. K., Juergens, N., Steinbacher, M., Reimann, S., Weilenmann, M., and Buchmann, B.: Road vehicle emissions of molecular hydrogen (H₂) from a tunnel study, *Atmos. Environ.*, 41, 8355–8369, doi:10.1016/j.atmosenv.2007.06.037, 2007.
- Werle, P., Mücke, R., and Slemr, F.: The limits of signal averaging in atmospheric trace-gas monitoring by tunable diode-laser absorption spectroscopy (TDLAS), *Appl. Phys. B-Laser O.*, 57, 131–139, doi:10.1007/BF00425997, 1993.
- Yakir, D. and Wang, X. F.: Fluxes of CO₂ and water between terrestrial vegetation and the atmosphere estimated from isotope measurements, *Nature*, 380, 515–517, doi:10.1038/380515a0, 1996.
- Zahn, A., Neubert, R., and Platt, U.: Fate of long-lived trace species near the Northern Hemispheric tropopause 2. Isotopic composition of carbon dioxide (¹³CO₂, ¹⁴CO₂, and C¹⁸O¹⁶O), *J. Geophys. Res.*, 105, 6719–6735, doi:10.1029/1999JD901000, 2000.
- Zeeman, M. J., Tuzson, B., Emmenegger, L., Knohl, A., Buchmann, N., and Eugster, W.: Conditional CO₂ flux analysis of a managed grassland with the aid of stable isotopes, *Biogeosciences Discuss.*, 6, 3481–3510, doi:10.5194/bgd-6-3481-2009, 2009.
- Zellweger, C., Forrer, J., Hofer, P., Nyeki, S., Schwarzenbach, B., Weingartner, E., Ammann, M., and Baltensperger, U.: Partitioning of reactive nitrogen (NO_y) and dependence on meteorological conditions in the lower free troposphere, *Atmos. Chem. Phys.*, 3, 779–796, doi:10.5194/acp-3-779-2003, 2003.
- Zellweger, C., Hüglin, C., Klausen, J., Steinbacher, M., Vollmer, M., and Buchmann, B.: Inter-comparison of four different carbon monoxide measurement techniques and evaluation of the long-term carbon monoxide time series of Jungfraujoch, *Atmos. Chem. Phys.*, 9, 3491–3503, doi:10.5194/acp-9-3491-2009, 2009.
- Zondervan, A. and Meijer, H. A. J.: Isotopic characterisation of CO₂ sources during regional pollution events using isotopic and radiocarbon analysis, *Tellus B*, 48, 601–612, doi:10.1034/j.1600-0889.1996.00013.x, 1996.